









CONNECTED TO INNOVATION











HOSE REELS





Compressed air



Closed-drum hose reels / STEEL				
	Reference	Hose diameter	Hose length	Page
	DSF	dia. 8 × 11 mm dia. 10 × 14 mm	3 m 5 m	8
	DMF	dia. 8 × 12 mm	10 m	10
	DRF	dia. 8 × 12 mm dia. 10 × 14 mm	10 m 12 m 15 m	11
	DRFB	dia. 8 × 12 mm dia. 10 × 14 mm	10 m 12 m 15 m	13
	DPF DPF SM	dia. 8 × 12 mm dia. 10 × 14 mm	10 m 12 m	15
	DGF	dia. 8 × 14 mm dia. 10 × 17 mm dia. 13 × 20 mm	10 m 15 m 20 m	16

Closed-drum hose reels / STAINLESS STEEL				
	Reference	Hose diameter	Hose length	Page
	DSFI	dia. 8 × 12 mm	5 m	9
	DRFI	dia. 10 × 14 mm	12 m	12
	DRFINB	dia. 10 × 14 mm	12 m	14

Open-drum hose reels / STEEL				
	DMO	dia. 8 × 14 mm dia. 10 × 17 mm dia. 13 × 20 mm	10 m 15 m 20 m	17
	DGO	dia. 10 × 17 mm dia. 13 × 20 mm dia. 16 × 23 mm	10 m 20 m 25 m	18
	DLO	dia. 13 × 20 mm dia. 16 × 23 mm dia. 19 × 27 mm	20 m 25 m 30 m	19
	DVO	dia. 10 × 14 mm	25 m	20
Portable hose reel				
	DMP	dia. 8 × 12 mm dia. 10 × 14 mm	30 m 25 m	21





Water

Open-drum hose reels / STEEL				
	Reference	Hose diameter	Hose length	Page
	DMO LS	dia. 16 × 24 mm	10 m	22
	DGO LS	dia. 16 × 24 mm	15 m	22
	DLO LS	dia. 16 × 24 mm dia. 19 × 27 mm	20 m 25 m	22

Open-drum hose reels / STAINLESS STEEL				
	Reference	Hose diameter	Hose length	Page
	DMOI LS	dia. 16 × 24 mm	10 m	23
	DGOI LS	dia. 16 × 24 mm	15 m	23
	DLOI LS	dia. 16 × 24 mm dia. 19 × 27 mm	20 m 25 m	23

Contents





High pressure hot water

Open-drum hose reels / STEEL				
	Reference	Hose diameter	Hose length	Page
	DMO HP	5/16" dia. 8 × 15 mm	15 m	24
	DGO HP	5/16" dia. 8 × 15 mm	20 m	24
Open-drum hose reels / STAINLESS STEEL				
	Reference	Hose diameter	Hose length	Page
	DMO HPI	5/16" dia. 8 × 15 mm	15 m	25
	DGO HPI	5/16" dia. 8 × 15 mm	20 m	25



Hose reels without hose

Hose reels without hose		
	Reference	Page
	DMO N - DMO NI - DGO NI - DMO NHP - DGO NHP - DMO NHPI - DGO NHPI	28

Grease, oil, gas

Drum hose reels for grease and oil				
	Reference	Hose diameter	Hose length	Page
	DMO GR	dia. 6.3 × 15.5 mm	10 m 15 m	26
	DGO GR	dia. 6.3 × 15.5 mm	20 m	26
	DMO OIL	dia. 12.7 × 19 mm	10 m	26
	DGO OIL	dia. 12.7 × 19 mm	15 m 20 m	26
Drum hose reel for gas				
	DGO SIC DGO OA	dia. 10 × 17 mm	15 m	27

Accessories

Swivel mounting brackets			
	Reference	Hose reel model	Page
	DMO PIV2 DGO PIV2 DLO PIV	Bracket for DMO Bracket for DGO Bracket for DLO	29
	DMOI PIV2 DGOI PIV2 DLOI PIV	Bracket for DMOI Bracket for DGOI Bracket for DLOI	29

The advantages that make the difference

Automatic hose reels are **essential equipment** for an **efficient workshop**. They **save time** and enable flexible distribution hoses to be used in total **safety and comfort**.

Available for the following fluids:

- compressed air,
- cold water and hot water at high and low pressure,
- oil, grease,
- oxygen and acetylene,

Prevost's comprehensive range of hose reels meets all requirements.

▾ DESIGN

Our extensive experience in the methods and techniques used to manufacture our hose reels ensures that they offer long-lasting reliability with no premature wear. The reels are fitted with appropriate hoses for the fluids carried:

- compressed air
- cold water and hot water, at high and low pressure
- grease and oil
- oxygen and acetylene.

The technology and the quality of the materials ensure that the reels are robust and effective.

▾ QUICK CONNECTION FITTINGS

Compressed air hose reels feature **prevo S1** quick safety couplings, offering hose whip protection and enabling single-press depressurisation and disconnection of pneumatic tools in total safety.

The range features various types of couplings:

- 6 mm, 7.4 mm, 8 mm and 11 mm clearance depending on the hose size and the corresponding air flow
- various profiles (British profile, 7.2/7.4 mm, ISO B, ARO, etc.) meeting the needs of international markets

▾ RETURN SPRING

The return spring system effortlessly winds the hose back into the reel housing. This extends the service life of hoses by ensuring that they are not left lying on the floor, where they would be exposed to contaminants, abrasion and a risk of crushing.

▾ TWIST PROTECTION

A twist protection system on the outlet connector ensures that the hose will not fold during use. Made from lightweight polyamide, the system prevents impact damage to hoses. Stainless steel reels feature stainless steel twist protection.



▾ CONTROLLED HOSE RETURN SYSTEM

(marked with a yellow travel limit stop)

The DRFB range features a braked return system which optimises operator safety and safeguards the work area.

The brake ensures that the hose is reeled in smoothly and progressively. This means that users can safely let go of a hose without it being reeled in unexpectedly fast.



▾ WALL-MOUNTED OR OVERHEAD INSTALLATION

Our hose reels can be mounted on a wall, overhead or fitted on a trolley, depending on the workshop layout, always ensuring good reach. A carefully placed reel reduces workshop clutter and increases productivity and convenience.

▾ SWIVEL OR FIXED MOUNTING BRACKET

All closed-drum reels (except DGF) feature swivel mounting brackets enabling the unit to rotate through 180°.

Open-drum reels feature fixed mounting brackets, but can also be fitted with 140° swivel brackets (optional references, see page 29) with mounting dimensions identical to those of fixed brackets.



▾ STOP CATCH

The reel mechanism includes a catch system that locks the hose at the length needed for the operator's work. This avoids the operator being hampered by heavy, cumbersome lengths of hose. Pulling on the hose releases the catch, enabling the return spring to automatically wind the hose back into the reel.

▾ TRAVEL LIMIT STOP

When the hose reel is not in use, the travel limit stop can be adjusted to set the length of hose that the user wishes to leave outside the housing. The position of the travel limit stop can be altered easily.



▾ SUPPLY HOSE

The hose reel is connected to the supply network via a supply hose provided with the reel, attached to a 360° rotating coupling fitted as standard.



▾ STEEL HOUSING

The housing is made from cold-stamped steel which is then hot galvanised and coated with a UV-resistant polyester powder coating. This technology ensures that housings are robust and offer high corrosion resistance while remaining environmentally friendly.



▾ STAINLESS STEEL HOUSING

Reels with AISI 304 stainless steel housings can be used in all environments, particularly those where corrosion resistance is important, including the food processing industry, slaughterhouses, institutional facilities, swimming pools, and so on.



Closed-drum hose reels



COMPRESSED AIR										
	DSF	DSFI	DMF	DRF	DRFI	DRFB	DRFINB	DPF	DGF	
Housing	Steel	Stainless steel	Steel	Steel	Stainless steel	Steel	Stainless steel	Steel	Steel	
Hose return						Controlled return system				
Hose	PU	PU	PU	PU/PVC	PU/PVC	PU/PVC	PU/PVC	PU	Rubber	
Bracket	Swivel								Fixed	
Air inlet	Supply hose: 1 m Rotating coupling on housing			Supply hose: 1 m Rotating coupling under plastic cover				Supply hose: 1 m Rotating coupling on housing		
Hose diameter (mm)	8 × 11 10 × 14	8 × 12	8 × 12	8 × 12 10 × 14	10 × 14	8 × 12 10 × 14	10 × 14	8 × 12 10 × 14	8 × 14 10 × 17 13 × 20	
Hose length (m)	3 5	5	10	10 12 15	12	10 12 15	12	10 12	10 15 20	
Pages	8	9	10	11	12	13	14	15	16	

Open-drum hose reels



COMPRESSED AIR - WATER - GREASE - OIL - OXYGEN - ACETYLENE											
	DMO	DGO	DLO	DVO	DMP	DMO LS	DGO LS	DLO LS	DMOI LS	DGOI LS	DLOI LS
Application	Air					Low pressure water					
Drum	Steel								Stainless steel		
Hose	Rubber			PU		Rubber					
Bracket	Fixed - optional swivel bracket available				Mobile		Fixed - optional swivel bracket available				
Air inlet	1 m supply hose - Rotating coupling on drum				Adaptor		1 m supply hose - Rotating coupling on drum				
Hose dia. (mm)	8 × 14 10 × 17 13 × 20	10 × 17 13 × 20 16 × 23	13 × 20 16 × 23 19 × 27	10 × 14	8 × 12 10 × 14	16 × 24	16 × 24	16 × 24 19 × 27	16 × 24	16 × 24	16 × 24 19 × 27
Hose length (m)	10 - 15 - 20	10 - 20 - 25	20 - 25 - 30	25	25 - 30	10	15	20 - 25	10	15	20 - 25
Pages	17	18	19	20	21	22	22	22	23	23	23

	DMO HP	DGO HP	DMO HPI	DGO HPI	DMO OIL	DGO OIL	DMO GR	DGO GR	DGO OA
Application	High pressure water				Oil		Grease		Oxy./Acety.
Drum	Steel		Stainless steel		Steel				
Hose	Rubber								
Bracket	Fixed - optional swivel bracket available								
Air inlet	Rotating coupling on drum								1 m supply hose
Hose dia. (mm)	5/16" - 8 x 15	5/16" - 8 x 15	5/16" - 8 x 15	5/16" - 8 x 15	12.7 × 19	12.7 × 19	6.3 × 15.5	6.3 × 15.5	10 × 17
Hose length (m)	15	20	15	20	10	15 - 20	10 - 15	20	15
Pages	24	24	25	25	26	26	26	26	27

DSF

Hose reels for **compressed air**

↘ Lightweight, compact model for individual distribution of compressed air in the workplace.

Air supply to portable pneumatic tools and for close work.

Hose reel fitted with a tough, flexible polyurethane hose.



↘ CHARACTERISTICS

- Galvanised steel housing with UV-resistant polyester-based electrostatic coating, treated steel spring
- Polyurethane hose with fabric braid
- 180° swivel bracket, wall or overhead mounting
- Air inlet: connected to the 360° rotating coupling at the centre of the housing, via the 1 m supply hose provided
- Temperature: -15°C to +40°C

↘ OUTLET COUPLING *

Air outlet fitted with a **prevo S1** quick safety coupling, offering hose whip protection and enabling single-press depressurisation and disconnection of pneumatic tools.

- **prevo S1** BSI quick safety coupling

Coupling profile:
British



- **prevo S1** ESI quick safety coupling

Coupling profile:
European 7.2 - 7.4 mm profile



- **prevo S1** ISI quick safety coupling

Coupling profile:
ISO 6150 series B.

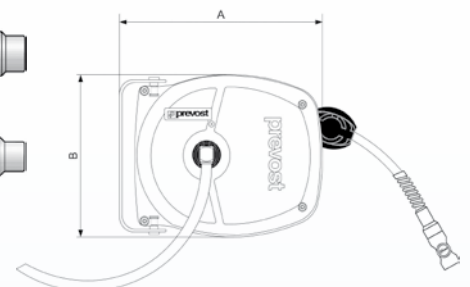

Reference	A	B	Hose diameter	Hose length	Air outlet quick connection fitting	Rotating supply hose	Hose reel outlet thread	Flow rate l/min at 6 bar	Pressure bar	Weight kg
			mm	m		mm				
DSF 0805BS	275	218	8 × 11	5	BSI 06	8 × 11	G 1/4 M	650	12	3
DSF 1003BS	275	218	10 × 14	3	BSI 06	10 × 14	G 3/8 M	750	12	3
DSF 0805ES	275	218	8 × 11	5	ESI 07	8 × 11	G 1/4 M	650	12	3
DSF 1003ES	275	218	10 × 14	3	ESI 07	10 × 14	G 3/8 M	1100	12	3
DSF 0805IS	275	218	8 × 11	5	ISI 06	8 × 11	G 1/4 M	650	12	3
DSF 1003IS	275	218	10 × 14	3	ISI 06	10 × 14	G 3/8 M	833	12	3

* Check with us for other quick coupling profiles.

DSFI

Stainless steel hose reels for **compressed air**

▾ Suitable for use in a damp, corrosive atmosphere.

Lightweight, compact model for individual distribution of compressed air in the workplace.

Air supply to portable pneumatic tools and for close work.

Hose reel fitted with a tough, flexible polyurethane hose.

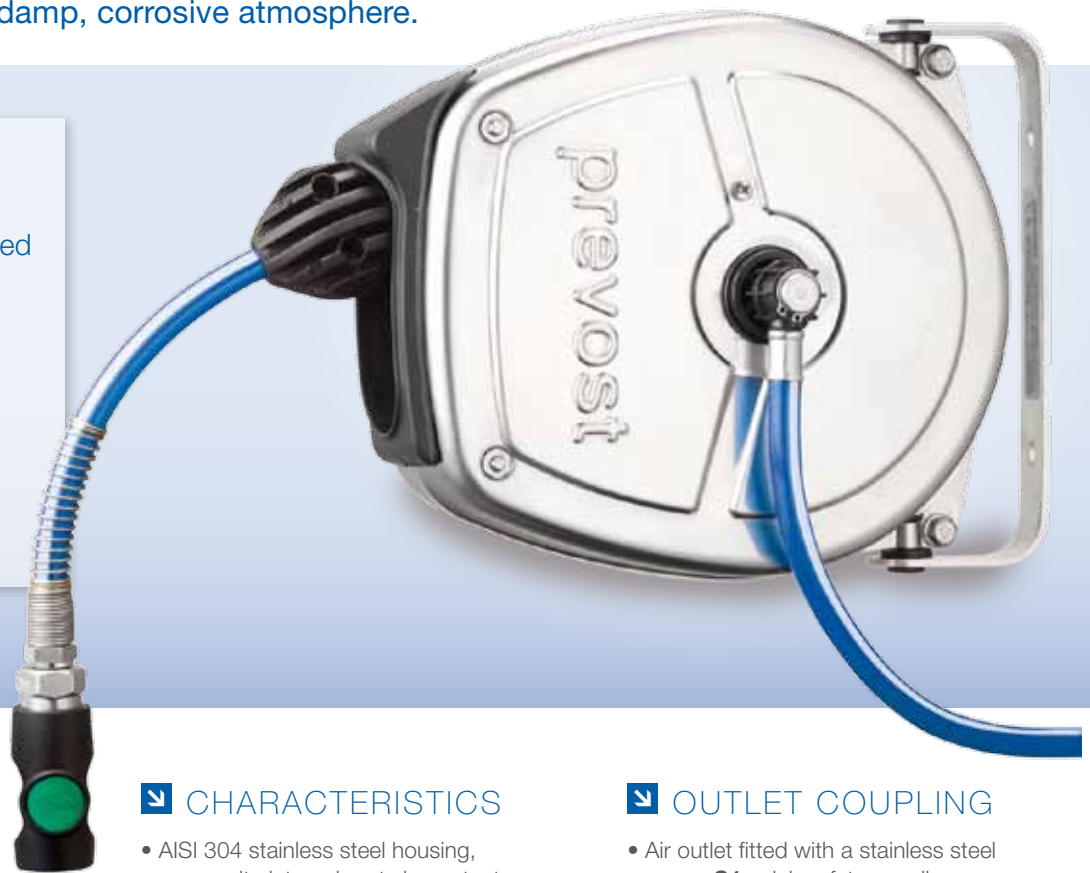

▾ CHARACTERISTICS

- AISI 304 stainless steel housing, composite internal parts in contact with the fluid
- Polyurethane hose with specific fabric braid, withstands heat and humidity
- 180° swivel bracket, wall or overhead mounting
- Air inlet: connected to the 360° rotating coupling at the centre of the housing, via the 1 m supply hose provided
- Temperature: -15°C to +40°C

▾ OUTLET COUPLING

- Air outlet fitted with a stainless steel **prevo S1** quick safety coupling, offering hose whip protection and enabling single-press depressurisation and disconnection of pneumatic tools.

Coupling profile:
European 7.2 - 7.4 mm profile

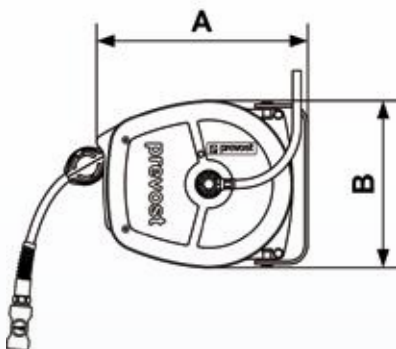

Reference	A	B	Hose diameter	Hose length	Air outlet quick connection fitting	Rotating supply hose	Hose reel outlet thread	Flow rate	Pressure	Weight
			mm	m		mm	l/min at 6 bar	bar	kg	
DSFI 0805ESHE	275	218	8 × 12	5	ESI 07HE	8 × 12	G 1/4 M	650	12	3

DMF

Hose reels for **compressed air**

↘ Versatile unit for close work
Hose length: 10 metres

Air supply to portable pneumatic tools, blowers and cleaners, and for close work.

Flexible, abrasion-resistant hose.



↘ CHARACTERISTICS

- Hot-dip galvanised moulded steel body with UV-resistant polyester-based electrostatic powder paint
- Polyurethane hose reinforced with fabric braid
- 180° swivel bracket, wall or overhead mounting
- Air inlet: connected to a 360° swivel coupling at the centre of the housing, via a 1 m supply hose provided
- Temperature: -15°C to +40°C

↘ OUTLET COUPLING *

Air outlet fitted with a **prevo S1** quick safety coupling, offering hose whip protection and enabling single-press depressurisation and disconnection of pneumatic tools.

- **prevo S1** BSI quick safety coupling

Coupling profile:
British

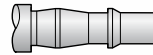

- **prevo S1** ESI quick safety coupling

Coupling profile:

European 7.2 - 7.4 mm profile



- **prevo S1** ISI quick safety coupling

Coupling profile:
ISO 6150 series B

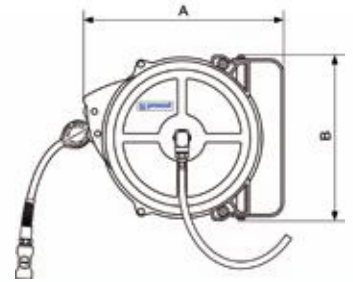

Reference	A	B	Hose diameter	Hose length	Air outlet quick connection fitting	Reel supply hose	Supply connector thread	Hose reel outlet thread	Flow rate	Pressure	Weight
			mm	m		mm		l/min at 6 bar	bar	kg	
DMF 0810BS	350	287	8 × 12	10	BSI 06	8 × 12	G 3/8 F	G 1/4 M	500	12	8
DMF 0810ES	350	287	8 × 12	10	ESI 07	8 × 12	G 3/8 F	G 1/4 M	500	12	8
DMF 0810IS	350	287	8 × 12	10	ISI 06	8 × 12	G 3/8 F	G 1/4 M	500	12	8

* Check with us for other quick coupling profiles.

DRF

Reels for compressed air

Functional unit, available with 10, 12 and 15-metre hose lengths

Air supply to portable pneumatic tools, blowers and cleaners, and for close work.

Polyurethane/thermoplastic hose with reinforced fabric braid.



CHARACTERISTICS

- Galvanised steel housing with UV-resistant polyester-based electrostatic powder coating, treated steel spring
- PU/PVC hose
- Air inlet: connection via 1 m supply hose provided, fitted on 360° rotating coupling protected by a plastic cover.
- 180° swivel bracket, wall or overhead mounting
- Temperature: -15°C to +65°C

OUTLET COUPLING *

Air outlet fitted with a **prevo S1** quick safety coupling, offering hose whip protection and enabling single-press depressurisation and disconnection of pneumatic tools.

- prevo S1** BSI quick safety coupling

Coupling profile:
British

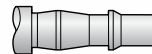

- prevo S1** ESI quick safety coupling

Coupling profile:
European 7.2 - 7.4 mm profile



- prevo S1** ISI quick safety coupling

Coupling profile:
ISO 6150 series B

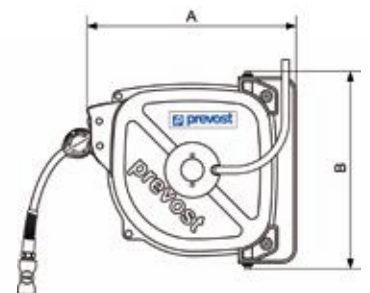

Reference	A	B	Hose diameter	Hose length	Air outlet quick connection fitting	Crimped supply hose to reel	Hose reel outlet thread	Flow rate	Pressure	Weight
			mm	m						
DRF 0812BS	340	302	8 × 12	12	BSI 06	8 × 12	G 1/4 M	500	12	5.8
DRF 0815BS	370	337	8 × 12	15	BSI 06	8 × 12	G 1/4 M	350	12	7.1
DRF 1010BS	340	302	10 × 14	10	BSI 06	10 × 14	G 3/8 M	750	12	5.7
DRF 1012BS	370	337	10 × 14	12	BSI 06	10 × 14	G 3/8 M	750	12	7
DRF 0812ES	340	302	8 × 12	12	ESI 07	8 × 12	G 1/4 M	500	12	5.8
DRF 0815ES	370	337	8 × 12	15	ESI 07	8 × 12	G 1/4 M	350	12	7.1
DRF 1010ES	340	302	10 × 14	10	ESI 07	10 × 14	G 3/8 M	900	12	5.7
DRF 1012ES	370	337	10 × 14	12	ESI 07	10 × 14	G 3/8 M	800	12	7
DRF 0812IS	340	302	8 × 12	12	ISI 06	8 × 12	G 1/4 M	500	12	5.8
DRF 0815IS	370	337	8 × 12	15	ISI 06	8 × 12	G 1/4 M	350	12	7.1
DRF 1010IS	340	302	10 × 14	10	ISI 06	10 × 14	G 3/8 M	833	12	5.7
DRF 1012IS	370	337	10 × 14	12	ISI 06	10 × 14	G 3/8 M	800	12	7

* Check with us for other quick coupling profiles.

DRFI

Stainless steel hose reels for **compressed air**

Product suitable for use in damp and corrosive environments

AISI 304 stainless steel housing.

Air outlet coupling suitable for damp environments: 316L stainless steel seal and sleeve.

For use outdoors, on quaysides, in food processing plants, collective facilities, swimming pools, superstores.



CHARACTERISTICS

- AISI 304 stainless steel housing, composite internal parts in contact with the fluid
- PU/PVC hose
- Air inlet: connection via 1 m supply hose provided, fitted on 360° rotating coupling protected by a plastic cover
- 180° swivel bracket, wall or overhead mounting
- Temperature: -15°C to +65°C

OUTLET COUPLING

- Air outlet fitted with a stainless steel **prevo S1** quick safety coupling, offering hose whip protection and enabling single-press depressurisation and disconnection of pneumatic tools.

Coupling profile:
European 7.2 - 7.4 mm profile



- Fluid: air

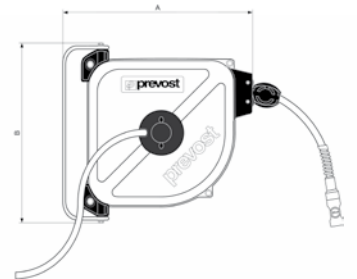

Reference	A	B	Hose diameter	Hose length	Air outlet quick connection fitting	Crimped supply hose to reel	Hose reel outlet thread	Flow rate l/min at 6 bar	Pressure bar	Weight kg
			mm	m		mm				
DRFI 1012ESHE	370	377	10 × 14	12	ESI 07HE	10 × 14	G 3/8 M	800	12	6.3

DRFB

INNOVATION

Hose reels for **compressed air** with controlled hose return system

↘ Extra-safe model

DRFB reels feature a controlled hose return system inside the housing.

A brake system ensures that the hose is reeled in smoothly and progressively.

This means that users can safely let go of a hose without it being reeled in unexpectedly fast.



↘ CHARACTERISTICS

- Galvanised steel housing with UV-resistant polyester-based electrostatic powder coating, treated steel spring
- PU/PVC hose
- Air inlet: connection via 1 m supply hose provided, fitted on 360° rotating coupling protected by a plastic cover
- Reels with controlled hose return are marked with a yellow travel limit stop
- 180° swivel bracket, wall or overhead mounting
- Temperature: -15°C to +65°C

↘ OUTLET COUPLING *

Air outlet fitted with a **prevo S1** quick safety coupling, offering hose whip protection and enabling single-press depressurisation and disconnection of pneumatic tools.

- **prevo S1** BSI quick safety coupling

Coupling profile:
British

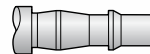

- **prevo S1** ESI quick safety coupling

Coupling profile:
European 7.2 - 7.4 mm profile



- **prevo S1** ISI quick safety coupling

Coupling profile:
ISO 6150 series B

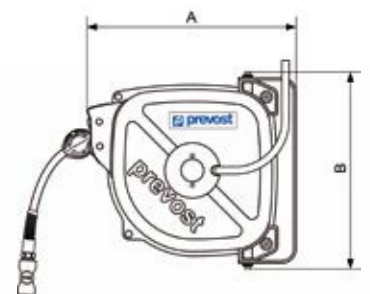

Reference	A	B	Hose diameter	Hose length	Air outlet quick connection fitting	Crimped supply hose to reel	Hose reel outlet thread	Flow rate	Pressure	Weight
			mm	m						
DRFB 0812BS	340	302	8 × 12	12	BSI 06	8 × 12	G 1/4 M	500	12	5.8
DRFB 0815BS	370	337	8 × 12	15	BSI 06	8 × 12	G 1/4 M	350	12	7.1
DRFB 1010BS	340	302	10 × 14	10	BSI 06	10 × 14	G 3/8 M	750	12	5.7
DRFB 1012BS	370	337	10 × 14	12	BSI 06	10 × 14	G 3/8 M	750	12	7
DRFB 0812ES	340	302	8 × 12	12	ESI 07	8 × 12	G 1/4 M	500	12	5.8
DRFB 0815ES	370	337	8 × 12	15	ESI 07	8 × 12	G 1/4 M	350	12	7.1
DRFB 1010ES	340	302	10 × 14	10	ESI 07	10 × 14	G 3/8 M	900	12	5.7
DRFB 1012ES	370	337	10 × 14	12	ESI 07	10 × 14	G 3/8 M	800	12	7
DRFB 0812IS	340	302	8 × 12	12	ISI 06	8 × 12	G 1/4 M	500	12	5.8
DRFB 0815IS	370	337	8 × 12	15	ISI 06	8 × 12	G 1/4 M	350	12	7.1
DRFB 1010IS	340	302	10 × 14	10	ISI 06	10 × 14	G 3/8 M	833	12	5.7
DRFB 1012IS	370	337	10 × 14	12	ISI 06	10 × 14	G 3/8 M	800	12	7

* Check with us for other quick coupling profiles.

Stainless steel hose reels for **compressed air** with controlled hose return

▾ Extra-safe model with stainless steel housing.

A brake system ensures that the hose is reeled in smoothly and progressively. This means that users can safely let go of a hose without it being reeled in unexpectedly fast.

For use outdoors, on quaysides, in food processing plants, collective facilities, swimming pools, superstores.



▾ CHARACTERISTICS

- DRFINB reels feature a controlled hose return system inside the housing (yellow hose limit stop)
- AISI 304 stainless steel housing, composite internal parts in contact with the fluid
- Product suitable for use in damp and corrosive environments
- PU/PVC hose
- Air inlet: connection via 1 m supply hose provided, fitted on 360° rotating coupling protected by a plastic cover
- 180° swivel bracket, wall or overhead mounting
- Temperature: -15°C to +65°C

▾ OUTLET COUPLING

- Air outlet fitted with a stainless steel **prevo S1** quick safety coupling, offering hose whip protection and enabling single-press depressurisation and disconnection of pneumatic tools.
- Coupling profile:*
European 7.2 - 7.4 mm profile 
- Fluid: air
 - 316L stainless steel seal and sleeve

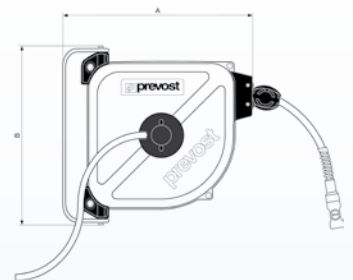

Reference	A	B	Hose diameter	Hose length	Air outlet quick connection fitting	Crimped supply hose to reel	Hose reel outlet thread	Flow rate l/min at 6 bar	Pressure bar	Weight kg
			mm	m						
DRFINB 1012ESHE	370	337	10 × 14	12	ESI 07HE	10 × 14	G 3/8 M	800	12	6.3

DPF/DPF SM

Hose reels for **compressed air**

Industrial hose reel, range of 12 metres

This intermediate-sized industrial hose reel for compressed air covers **a wide range of needs.**

It can be installed on a pivoting bracket for wall or overhead mounting, or on a trolley enabling the reel to be moved around the workshop.

Hose reel fitted with a flexible, abrasion-resistant polyurethane hose.



CHARACTERISTICS

- Hot-dip galvanised moulded steel housing with UV-resistant polyester-based electrostatic powder paint.
- Polyurethane hose reinforced with fabric braid
- 180° swivel mounting bracket
- Model on swivel bracket: ref. DPF SMO
- Air inlet: connected to the 360° rotating coupling at the centre of the housing, via the 1 m supply hose provided
- Temperature: -15°C to +40°C

OUTLET COUPLING *

Air outlet with:

- **prevo S1** BSI quick safety coupling

Coupling profile:
British

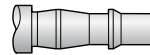

- **prevo S1** ESI quick safety coupling

Coupling profile:
European 7.2 - 7.4 mm profile



- **prevo S1** ISI quick safety coupling

Coupling profile:
ISO 6150 series B

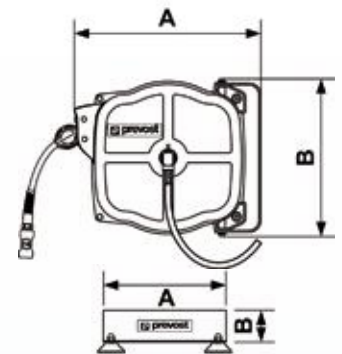

Reference	A	B	Hose diameter	Hose length	Air outlet quick connection fitting	Reel supply hose	Thread inlet connector	Hose reel outlet thread	Flow rate	Pressure	Weight
			mm	m							
DPF 0812BS	377	317	8 × 12	12	BSI 06	8 × 12	G 3/8 F	G 1/4 M	500	12	9
DPF 0812ES	377	317	8 × 12	12	ESI 07	8 × 12	G 3/8 F	G 1/4 M	500	12	9
DPF 1010ES	377	317	10 × 14	10	ESI 07	10 × 14	G 3/8 F	G 1/4 M	900	12	9
DPF 0812IS	377	317	8 × 12	12	ISI 06	8 × 12	G 3/8 F	G 1/4 M	500	12	9
DPF 1010IS	377	317	10 × 14	10	ISI 06	10 × 14	G 3/8 F	G 3/8 F	833	12	9
DPF 0812 reel with mobile stand: ref. DPF SMOSR											
Mobile stand only: ref. DPF SMON											
DPF SMOSR	377	317	8 × 12	12	-	8 × 12	G 3/8 F	G 1/4 M	500	16	11
DPF SMON	345	65									2.8

* Check with us for other quick coupling profiles.

Hose reels for **compressed air**

▣ Large-sized unit with wide range of flow rates

Oil-, grease- and water-resistant hose.

Large-sized reel covering a **wide range of flow rates**.

Supply to pneumatic tools with **medium and high consumption**.



▣ CHARACTERISTICS

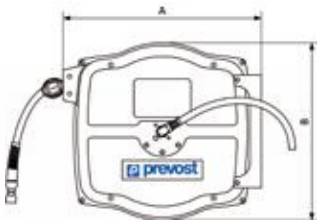

- Hot-dip galvanised moulded steel housing with UV-resistant polyester-based electrostatic powder paint



- Rubber hose, with NBR (rubber neoprene) inner lining and CR-SBR (rubber neoprene) outer coating
- Fixed bracket
- Optional 140° swivel bracket: DGF PIV
- Air inlet: connected to the 360° rotating coupling at the centre of the housing, via the 1 m supply hose provided
- Temperature: -15°C to +40°C

▣ OUTLET COUPLING *

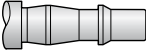
Air outlet with:

- **prevo S1** BSI quick safety coupling
Coupling profile: *British* 
- **prevo S1** ESI quick safety coupling
Coupling profile: *European 7.2 - 7.4 mm profile* 
- **prevo S1** ISI quick safety coupling
Coupling profile: *ISO 6150 series B* 

Reference	A	B	Hose diameter	Hose length	Air outlet quick connection fitting	Reel supply hose	Thread inlet connector	Hose reel outlet thread	Flow rate	Pressure	Weight
			mm	m							
DGF 0810BS	520	462	8 × 14	10	BSI 06	8 × 14	G 3/8 F	G 3/8 M	500	12	17
DGF 0815BS	520	462	8 × 14	15	BSI 06	8 × 14	G 3/8 F	G 3/8 M	350	12	18.5
DGF 0820BS	520	462	8 × 14	20	BSI 06	8 × 14	G 3/8 F	G 3/8 M	260	12	20
DGF 0810ES	520	462	8 × 14	10	ESI 07	8 × 14	G 3/8 F	G 3/8 M	500	12	17
DGF 0815ES	520	462	8 × 14	15	ESI 07	8 × 14	G 3/8 F	G 3/8 M	350	12	18.5
DGF 0820ES	520	462	8 × 14	20	ESI 07	8 × 14	G 3/8 F	G 3/8 M	260	12	20
DGF 1010ES	520	462	10 × 17	10	ESI 07	10 × 17	G 3/8 F	G 3/8 M	900	12	18
DGF 1015ES	520	462	10 × 17	15	ESI 07	10 × 17	G 3/8 F	G 3/8 M	700	12	19
DGF 1310ES	520	462	13 × 20	10	ESI 07	13 × 20	G 1/2 M	G 1/2 M	1800	12	19
DGF 0810IS	520	462	8 × 14	10	ISI 06	8 × 14	G 3/8 F	G 3/8 M	500	12	17
DGF 0815IS	520	462	8 × 14	15	ISI 06	8 × 14	G 3/8 F	G 3/8 M	350	12	18.5
DGF 0820IS	520	462	8 × 14	20	ISI 06	8 × 14	G 3/8 F	G 3/8 M	260	12	20
DGF 1010IS	520	462	10 × 17	10	ISI 06	10 × 17	G 3/8 F	G 3/8 M	833	12	18
DGF 1015IS	520	462	10 × 17	15	ISI 06	10 × 17	G 3/8 F	G 3/8 M	700	12	19
DGF 1310IS	520	462	13 × 20	10	ISI 08	13 × 20	G 1/2 M	G 1/2 M	1800	12	19

* Check with us for other quick coupling profiles.

DMO steel

Hose reels for **compressed air**

Professional unit covering a wide range of diameters and lengths

Technically proven model, featuring an **extremely robust hose**.

Withstands oil, grease, water and adverse weather conditions.

Model suitable for a **host of configurations in extremely harsh conditions**.

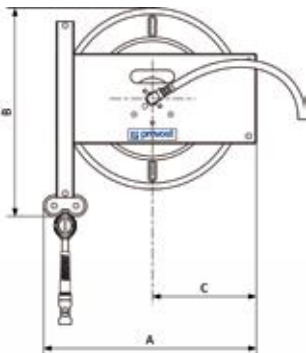

CHARACTERISTICS

- Hot-dip galvanised moulded steel housing with UV-resistant polyester-based electrostatic powder paint
- Rubber hose
- Steel protection spring for 13 × 20 mm diameter hose
- Fixed bracket
- Optional 140° swivel bracket: DMO PIV2
- Air inlet: connected to the 360° rotating coupling at the centre of the housing, via the 1 m supply hose provided
- Temperature: -15°C to +40°C

OUTLET COUPLING *

Air outlet with:

- **prevo S1** BSI quick safety coupling
Coupling profile: *British*

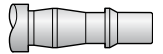

- **prevo S1** ESI quick safety coupling
Coupling profile: *European 7.2 - 7.4 mm profile*



- **prevo S1** ISI quick safety coupling
Coupling profile: *ISO 6150 series B*.



Reference	A	B	C	Hose diameter	Hose length	Air outlet quick connection fitting	Reel supply hose	Thread inlet connector	Hose reel outlet thread	Flow rate	Pressure	Weight
				mm	m							
DMO 0810BS	485	475	237	8 × 14	10	BSI 06	8 × 14	G 3/8 F	G 3/8 M	500	12	16
DMO 0815BS	485	475	237	8 × 14	15	BSI 06	8 × 14	G 3/8 F	G 3/8 M	350	12	17.5
DMO 0820BS	485	475	237	8 × 14	20	BSI 06	8 × 14	G 3/8 F	G 3/8 M	260	12	19
DMO 1010BS	485	475	237	10 × 17	10	BSI 06	10 × 17	G 3/8 F	G 3/8 M	750	12	17
DMO 1015BS	485	475	237	10 × 17	15	BSI 06	10 × 17	G 3/8 F	G 3/8 M	700	12	19
DMO 1020BS	485	475	237	10 × 17	20	BSI 06	10 × 17	G 3/8 F	G 3/8 M	660	12	22
DMO 0810ES	485	475	237	8 × 14	10	ESI 07	8 × 14	G 3/8 F	G 3/8 M	500	12	16
DMO 0815ES	485	475	237	8 × 14	15	ESI 07	8 × 14	G 3/8 F	G 3/8 M	350	12	17.5
DMO 0820ES	485	475	237	8 × 14	20	ESI 07	8 × 14	G 3/8 F	G 3/8 M	260	12	19
DMO 1010ES	485	475	237	10 × 17	10	ESI 07	10 × 17	G 3/8 F	G 3/8 M	900	12	17
DMO 1015ES	485	475	237	10 × 17	15	ESI 07	10 × 17	G 3/8 F	G 3/8 M	700	12	19
DMO 1020ES	485	475	237	10 × 17	20	ESI 07	10 × 17	G 3/8 F	G 3/8 M	660	12	22
DMO 1315ES	485	475	237	13 × 20	15	ESI 07	13 × 20	G 1/2 M	G 1/2 M	1400	12	22
DMO 0810IS	485	475	237	8 × 14	10	ISI 06	8 × 14	G 3/8 F	G 3/8 M	500	12	16
DMO 0815IS	485	475	237	8 × 14	15	ISI 06	8 × 14	G 3/8 F	G 3/8 M	350	12	17.5
DMO 0820IS	485	475	237	8 × 14	20	ISI 06	8 × 14	G 3/8 F	G 3/8 M	260	12	19
DMO 1010IS	485	475	237	10 × 17	10	ISI 06	10 × 17	G 3/8 F	G 3/8 M	833	12	17
DMO 1015IS	485	475	237	10 × 17	15	ISI 06	10 × 17	G 3/8 F	G 3/8 M	700	12	19
DMO 1020IS	485	475	237	10 × 17	20	ISI 06	10 × 17	G 3/8 F	G 3/8 M	660	12	22
DMO 1315IS	485	475	237	13 × 20	15	ISI 08	13 × 20	G 1/2 M	G 1/2 M	1400	12	22

* Check with us for other quick coupling profiles.

DGO steel

Hose reels for **compressed air**

▾ Large-size professional model, wide range of flow rates

Technically proven model, featuring an **extremely sturdy hose**.

Withstands oil, grease, water and adverse weather conditions.

Model suitable for **a host of configurations** in **extremely harsh conditions**.

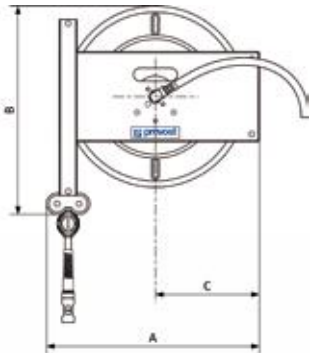



▾ CHARACTERISTICS

- Hot-dip galvanised moulded steel housing with UV-resistant polyester-based electrostatic powder paint
 - Rubber hose
 - Features a polyamide hose protector for 10 × 17 mm diameter hose
- Other hose diameters have a steel protection spring.
- Fixed bracket
 - Optional 140° swivel bracket: DGO PIV2
 - Air inlet: connected to the 360° rotating coupling at the centre of the housing, via the 1 m supply hose provided
 - Temperature: -15°C to +40°C

▾ OUTLET COUPLING*

Air outlet with:

- **prevo S1** ESI quick safety coupling
Coupling profile: *European 7.2 - 7.4 mm profile* 
- **prevo S1** ISI quick safety coupling
Coupling profile: *ISO 6150 series B* 
- **ISG 11** quick safety coupling
Coupling profile: *ISO 6150 series B (model DGO 1610)* 

Reference	A	B	C	Hose diameter	Hose length	Air outlet quick connection fitting	Reel supply hose	Thread inlet connector	Hose reel outlet thread	Flow rate	Pressure	Weight
				mm	m		mm			l/min at 6 bar	bar	kg
DGO 1025ES	485	475	237	10 × 17	25	ESI 07	10 × 17	G 3/8 F	G 3/8 F	500	12	26
DGO 1320ES	485	475	237	13 × 20	20	ESI 07	13 × 20	G 1/2 M	G 1/2 M	1000	12	27
DGO 1610ES	485	475	237	16 × 23	10	ESI 11	16 × 23	G 1/2 M	G 1/2 M	3000	16	25
DGO 1025IS	485	475	237	10 × 17	25	ISI 06	10 × 17	G 3/8 F	G 3/8 F	500	12	26
DGO 1320IS	485	475	237	13 × 20	20	ISI 08	13 × 20	G 1/2 M	G 1/2 M	1000	12	27
DGO 1610IS	485	475	237	16 × 23	10	ISI 11	16 × 23	G 1/2 M	G 1/2 M	3000	16	25
DGO 1610	485	475	237	16 × 23	10	ISG 11	16 × 23	G 1/2 M	G 1/2 M	3000	12	25

* Check with us for other quick coupling profiles.

DLO

Hose reels for **compressed air**

High capacity model equipped with 11 mm quick coupling

Hose reel for air or water supply to tools with **medium and high consumption levels**, with long hose lengths.

For use in institutional facilities, superstores, public works, HGV servicing, etc.



CHARACTERISTICS

- Hot-dip galvanised moulded steel housing with UV-resistant polyester-based electrostatic powder paint
- Rubber hose
- Steel protection spring
- Fixed bracket
- Optional 140° swivel bracket, ref. DLO PIV
- Air inlet: 1 m supply hose fitted on 360° rotating coupling
- Temperature: -15°C to +70°C

OUTLET COUPLING *

Air outlet with **11 mm** coupling:

- **prevo S1** ISI and ESI quick safety coupling
Coupling profile: European 10.4 (model DLO ES)
Coupling profile: ISO 6150 series B (model DLO IS)
- ISG 11 quick safety coupling
Coupling profile: ISO 6150 series B (model DLO)

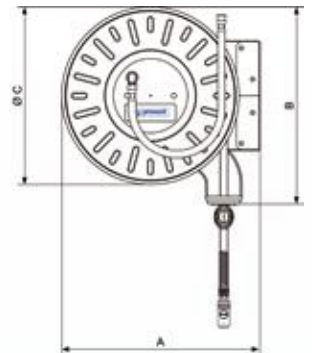
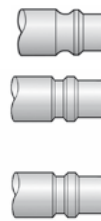

Reference	A	B	C	Hose diameter	Hose length	Air outlet quick connection fitting	Hose reel inlet thread	Hose reel outlet thread	Flow rate l/min at 6 bar	Pressure bar	Weight kg
				mm	m						
DLO 1330ES	615	610	550	13 × 20	30	ESI 11	G 1/2 M	G 1/2 M	850	16	39
DLO 1625ES	615	610	550	16 × 23	25	ESI 11	G 1/2 M	G 1/2 M	1700	16	41
DLO 1920ES	615	610	550	19 × 27	20	ESI 11	G 1 M	G 3/4 F	2400	16	42
DLO 1330IS	615	610	550	13 × 20	30	ISI 11	G 1/2 M	G 1/2 M	850	16	39
DLO 1625IS	615	610	550	16 × 23	25	ISI 11	G 1/2 M	G 1/2 M	1700	16	41
DLO 1920IS	615	610	550	19 × 27	20	ISI 11	G 1 M	G 3/4 F	2400	16	42
DLO 1330	615	610	550	13 × 20	30	ISG 11	G 1/2 M	G 1/2 M	850	12	39
DLO 1625	615	610	550	16 × 23	25	ISG 11	G 1/2 M	G 1/2 M	1700	12	41
DLO 1920	615	610	550	19 × 27	20	ISG 11	G 1 M	G 3/4 F	2400	12	42

* Check with us for other quick coupling profiles.

DVO

Hose reels for **compressed air**

Supply to pneumatic tools in large work areas

The lightweight, flexible polyurethane hose can be **easily handled** despite its length (25 metres).



CHARACTERISTICS

- Hot-dip galvanised moulded steel housing with UV-resistant polyester-based electrostatic powder paint
- Braided polyurethane hose
- Three-position adjustable air outlet arm
- Fixed bracket
- Optional 140° swivel bracket, ref. DMO PIV2
- Air inlet: connection via 1 m supply hose provided, fitted on 360° rotating coupling protected by a plastic cover
- Max. temperature: -15°C to +40°C

OUTLET COUPLING *

Air outlet with:

- **prevo S1** ISI quick safety coupling

Coupling profile:
ISO 6150 series B
(model DVO 1025IS)



- **prevo S1** ESI quick safety coupling

Coupling profile:
European 7.2 - 7.4 mm profile

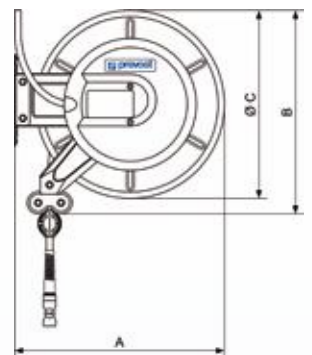

Reference	A	B	C	Hose diameter	Hose length	Air outlet quick connection fitting	Reel supply hose	Thread inlet connector	Hose reel outlet thread	Flow rate	Pressure	Weight
				mm	m		mm		l/min at 6 bar	bar	kg	
DVO 1025ES	460	447	413	10 × 14	25	ESI 07	10 × 14	G 3/8 F	G 3/8 M	500	12	23
DVO 1025IS	460	447	413	10 × 14	25	ISI 06	10 × 14	G 3/8 F	G 3/8 M	500	12	23

* Check with us for other quick coupling profiles.

DMP

Hose reels for **compressed air**

Portable hose reel

The metal structure of the hose reel enables it to be **moved with ease**, ensures **stability** on the floor and protects the hose.

The hose reel may also be wall-mounted at a fixed work station.



CHARACTERISTICS

- Hot-dip galvanised steel housing and bracket, UV-resistant blue varnish coating
- Polyurethane / thermoplastic hose with fabric braid
- Collapsible winding handle
- Air inlet: 2 metres of hose fitted with a quick coupling connection fitting
- Temperature: -4°C to +70°C

OUTLET COUPLING

Air outlet with 6 mm coupling:

- **prevo S1** ESI quick safety coupling

Coupling profile:
European 7.2 - 7.4 mm profile



- **prevo S1** ISI quick safety coupling

Coupling profile:
ISO 6150 series B

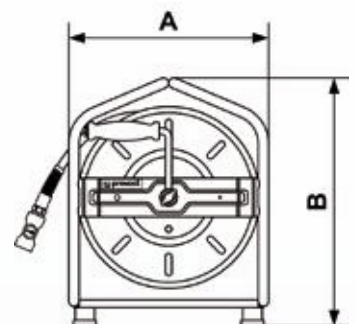

Reference	A	B	Hose diameter	Hose length	Air outlet quick connection fitting	Air supply fitting	Hose reel inlet thread	Hose reel outlet thread	Flow rate l/min at 6 bar	Pressure bar	Weight kg
			mm	m							
DMP 0830ES	310	385	8 × 12	30	ESI 07	ERP 07	G 1/4 M	G 1/4 M	400	12	8.4
DMP 1025ES	310	385	10 × 14	25	ESI 07	ERP 07	G 3/8 M	G 3/8 M	600	12	8.4
DMP 0830IS	310	385	8 × 12	30	ISI 06	IRP 06	G 1/4 M	G 1/4 M	400	12	8.4
DMP 1025IS	310	385	10 × 14	25	ISI 06	IRP 06	G 3/8 M	G 3/8 M	600	12	8.4

DMO LS / DGO LS / DLO LS

Hose reels for **low pressure water**

▾ Hose reel for industrial use:
low pressure water supply

Cleaning, scouring,
watering.

Industry, public works,
institutional facilities,
superstores.

Food grade rubber
hose, withstands greases,
animal and vegetable fats.

Durable even at **high**
temperatures.



DGO LS
(with swivel bracket)

▾ CHARACTERISTICS

- Hot-dip galvanised moulded steel housing with UV-resistant polyester-based electrostatic powder paint
- Rubber hose
- Steel protection spring
- Fixed bracket
- Optional 140° swivel bracket: DMO PIV2
- Air inlet: 1 m supply hose fitted on 360° rotating coupling
- Temperature: -15°C to +60°C

▾ OUTLET COUPLING

- Air outlet with automatic water coupling, standard profile, ELS 09

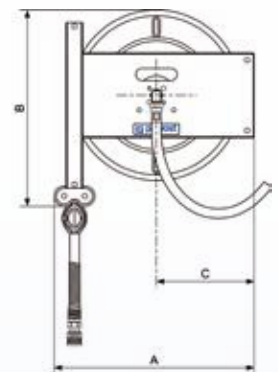

Reference	A	B	C	Hose diameter	Hose length	Air outlet quick connection fitting	Reel supply hose	Supply connector thread	Hose reel outlet thread	Pressure bar	Weight kg
				mm	m		mm				
DMO 1610LS	485	475	237	16 × 24	10	ELS 09	16 × 24	G 1/2 M	G 1/2 M	10	20
DGO 1615LS	485	475	237	16 × 24	15	ELS 09	16 × 24	G 1/2 M	G 1/2 M	10	25
DLO 1625LS	624	610	340	16 × 24	25	ELS 09	16 × 24	G 1/2 M	G 1/2 M	10	44
DLO 1920LS	624	610	340	19 × 27	20	ELS 09	19 × 28	G 1 M	G 3/4 M	10	42

DMOI LS / DGOI LS / DLOI LS

Stainless steel hose reel for **low pressure water**

Water distribution at low pressure

The AISI 304 stainless steel body enables these reels to be used in environments where corrosion resistance is important.

They are suitable for use in industrial kitchens, slaughterhouses, dairies, food processing, chemical and pharmaceutical plants and swimming pools.



DMOI LS
(with swivel bracket)

CHARACTERISTICS

- Stainless steel 304 housing
- Fixed bracket
- Optional 140° swivel bracket, ref. DMOI PIV2, DGOI PIV2, DLOI PIV
- Air inlet: 1 m supply hose fitted on 360° rotating coupling
- Temperature: -15°C to +60°C

OUTLET COUPLING

- Water outlet with automatic water coupling, standard profile, ELS 09.

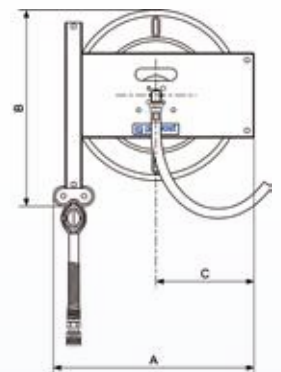

Reference	A	B	C	Hose diameter	Hose length	Air outlet quick connection fitting	Reel supply hose	Supply connector thread	Hose reel outlet thread	Pressure bar	Weight kg
				mm	m		mm				
DMOI 1610LS	485	475	237	16 × 24	10	ELS 09	16 × 24	G 1/2 M	G 1/2 M	10	20
DGOI 1615LS	485	475	237	16 × 24	15	ELS 09	16 × 24	G 1/2 M	G 1/2 M	10	25
DLOI 1625LS	624	610	340	16 × 24	25	ELS 09	16 × 24	G 1/2 M	G 1/2 M	10	44
DLOI 1920LS	624	610	340	19 × 27	20	ELS 09	19 × 27	G 1 M	G 3/4 M	10	42

DMO HP / DGO HP

Hose reels for **hot water - high pressure**

Water distribution at high pressure

Applications: high-pressure washers, high pressure hot water equipment, public works, food processing.



DGO HP
(with swivel bracket)

CHARACTERISTICS

- Hot-dip galvanised moulded steel housing with UV-resistant polyester-based electrostatic powder paint
- Rubber hose
- Fixed bracket
- Optional 140° swivel bracket: DMO PIV2, DGO PIV2
- Air inlet: connected to the 360° rotating coupling in the centre of the housing
- Temperature: -40°C to +150°C



Optional connection hose (DMG KITHP) between hot water machine and HP reel.

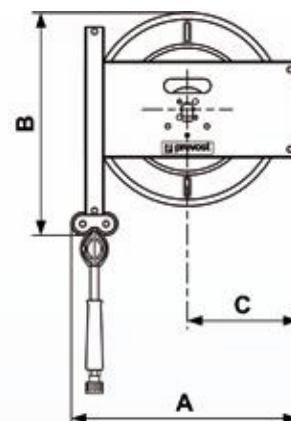

Reference	A	B	C	Hose diameter	Hose length	Reel supply hose	Supply connector thread	Hose reel outlet thread	Pressure	Weight
				mm	m	mm		bar	kg	
DMO 0815HP	485	475	237	5/16" - 8 x 15	15	5/16" - 8 x 15	G 3/8 F	G 3/8 M + 22 x 150	400	16
DGO 0820HP	485	475	237	5/16" - 8 x 15	20	5/16" - 8 x 15	G 3/8 F	G 3/8 M + 22 x 150	400	21
Heavy-duty connection hose for hot water machine										
DMG KITHP3				5/16" - 8 x 15	3		G 3/8 + 22 x 150	G 3/8 + 22 x 150	400	
DMG KITHP6				5/16" - 8 x 15	6		G 3/8 + 22 x 150	G 3/8 + 22 x 150	400	

DMO HPI / DGO HPI

Stainless steel hose reels
for **hot water - high pressure**

Water distribution at high pressure

The AISI 304 stainless steel body enables these reels to be used in environments where **corrosion resistance is important.**

They are suitable for use in industrial kitchens, slaughterhouses, dairies, food processing, chemicals and pharmaceutical plants and swimming pools.



DGO HPI
(with swivel bracket)

CHARACTERISTICS

- Stainless steel housing
- Rubber hose
- Fixed bracket
- Optional 140° swivel bracket, ref. DMOI PIV2, DGOI PIV2
- Air inlet: connected to the 360° rotating coupling in the centre of the housing
- Temperature: -40°C to +150°C



Optional connection hose (DMG KITHP) between hot water machine and HP reel.

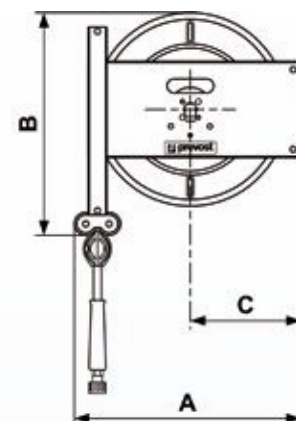

Reference	A	B	C	Hose diameter	Hose length	Reel supply hose	Supply connector thread	Hose reel outlet thread	Pressure	Weight
				mm	m	mm		bar	kg	
DMO 0815HPI	485	475	237	5/16" - 8 x 15	15	5/16" - 8 x 15	G 3/8 F	G 3/8 M + 22 x 150	400	16
DGO 0820HPI	485	475	237	5/16" - 8 x 15	20	5/16" - 8 x 15	G 3/8 F	G 3/8 M + 22 x 150	400	21
Heavy-duty connection hose for hot water machine										
DMG KITHP3				5/16" - 8 x 15	3		G 3/8 + 22 x 150	G 3/8 + 22 x 150	400	
DMG KITHP6				5/16" - 8 x 15	6		G 3/8 + 22 x 150	G 3/8 + 22 x 150	400	

DMO GR / DGO GR / DMO OIL / DGO OIL

Hose reels for grease and oil

Direct supply from an oil or grease tank to the point of application.

Mechanical engineering, garages, service stations, lubrication and servicing facilities.

Hose withstands inorganic and organic oils, grease, water, water/oil emulsions, as well as abrasion and adverse weather conditions.



CHARACTERISTICS

- Hot-dip galvanised moulded steel housing with UV-resistant polyester-based electrostatic powder paint
- Synthetic rubber hose reinforced with two metal braids (grease hose reel) or one metal braid (oil hose reel)
- Fixed bracket
- Optional 140° swivel bracket: DMO PIV2 and DGO PIV2

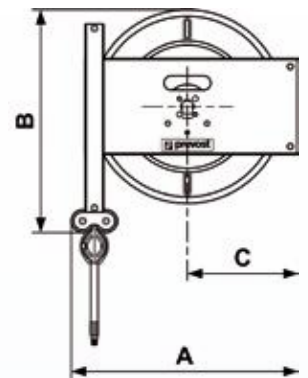

Reference	A	B	C	Fluid	Temperatures	Hose diam.	Hose length	Reel supply hose	Supply connector thread	Hose reel outlet thread	Pressure	Weight
					°C	mm	m	mm			bar	kg
DMO 0610GR	485	475	237	Grease	-10°C to +100°C	6.3 × 15.5	10	6.3 × 15.5	G 1/4 F	G 1/4 M	400	18.5
DMO 0615GR	485	475	237			6.3 × 15.5	15	6.3 × 15.5	G 1/4 F	G 1/4 M	400	20.5
DGO 0620GR	485	475	237			6.3 × 15.5	20	6.3 × 15.5	G 1/4 F	G 1/4 M	400	27
DMO 1310OIL	485	475	237	Oil	-10°C to +40°C	12.7 × 19	10	12.7 × 19	G 1/2 M	G 1/2 M	60	18
DGO 1315OIL	485	475	237			12.7 × 19	15	12.7 × 19	G 1/2 M	G 1/2 M	60	23
DGO 1320OIL	485	475	237			12.7 × 19	20	12.7 × 19	G 1/2 M	G 1/2 M	60	26.5

DGO OA

Hose reels for **gas** (welding facilities)

Dual rubber hose for oxygen and acetylene distribution, in compliance with **EN 559**.

Applications: oxy-welding, oxy-cutting.



CHARACTERISTICS

- Hot-dip galvanised moulded steel housing with UV-resistant polyester-based electrostatic powder paint
- Rubber hose
- Fixed bracket
- Air inlet: 2 × 1 m supply hoses fitted on 360° rotating coupling

OUTLET COUPLING

- Outlets: model DGO 1015SIC equipped with quick safety couplings, on the oxygen hose and the acetylene hose, with non-return gas valves and flashback arrestors for welder protection.

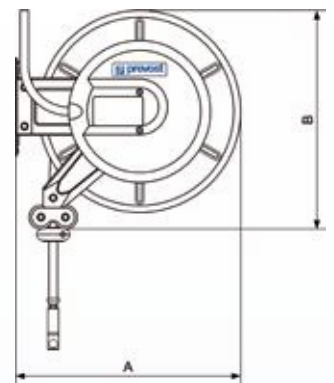

Reference	A	B	Hose diam.	Hose length	Reel supply hose	Air outlet quick connection fitting	Pressure	Weight
			mm	m	mm		bar	kg
DGO 1015OA	485	475	10 × 17	15	10 × 17	none	20	25
DGO 1015SIC	485	475	10 × 17	15	10 × 17	ISOFLAM safety coupling SIO 061810S2 - SIA 061810S2	Acetylene: 1.5 bar Oxygen: 12.5 bar	25

Hose reels without hose

Low and high pressure

▾ Reels delivered without hose, for fitting specific hoses



▾ CHARACTERISTICS

- Galvanised steel housing with electrostatic paint, or 304 stainless steel housing
- Fixed bracket
- Optional 140° swivel bracket

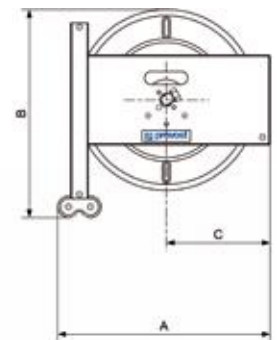

Reference *	A	B	C	Rotating coupling inlet thread	Outlet on drum	* Hose length capacity	Hose OD capacity	Body material	Weight
						m	mm		kg
DMO N	485	475	237	G 3/8 F	G 3/8 M	15	20	Steel	15
DMO NI	485	475	237	G 1/2 F	G 1/2 M	15	20	Stainless steel	15
DGO NI	485	475	237	G 1/2 F	G 1/2 M	20	20	Stainless steel	20
DMO NHP	485	475	237	G 3/8 F	G 3/8 M	15	17	Steel	15
DGO NHP	485	475	237	G 3/8 F	G 3/8 M	20	17	Steel	20
DMO NHPI	485	475	237	G 3/8 F	G 3/8 M	15	17	Stainless steel	15
DGO NHPI	485	475	237	G 3/8 F	G 3/8 M	20	17	Stainless steel	20

* : The capacity of the drum varies depending on the selected hose diameter.

Accessories

Swivel mounting brackets

Hose reel swivels through 140°.

The reel is stopped before it touches the side walls, preserving both the housing and the wall.

Quick and safe to install.

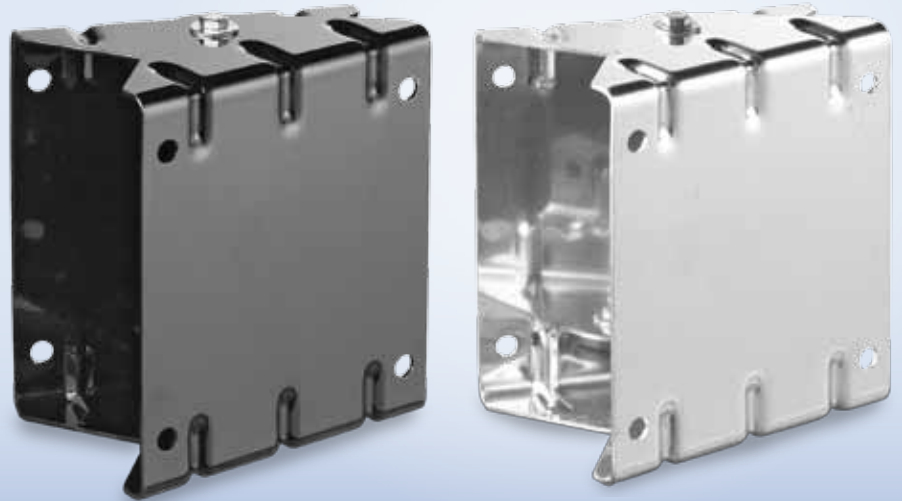

Easy to fit the hose reel mounted to the plate.

The spacing of the holes on the fixed bracket on the hose reel corresponds to the spacing on the swivel bracket.

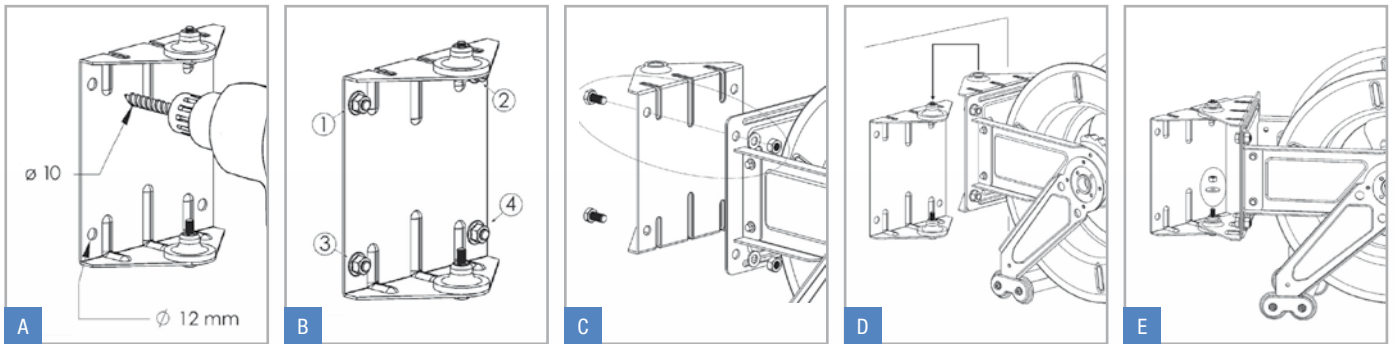

Installation of DMO PIV2 and DGO PIV2 brackets



	Reference	A	B	C	D	Material	For hose reels
	DMO PIV2	180	205	150	150	Treated steel	Bracket for DMO
	DGO PIV2	230	205	200	150	Treated steel	Bracket for DGO
	DLO PIV	160	368	124	300	Treated steel	Bracket for DLO
	DMOI PIV2	180	205	150	150	304 stainless steel	Bracket for DMOI
	DGOI PIV2	230	205	200	150	304 stainless steel	Bracket for DGOI
	DLOI PIV	160	368	124	300	304 stainless steel	Bracket for DLOI
	DGF PIV	427	30	292	Diam. 10.5	Treated steel	Bracket for DGF

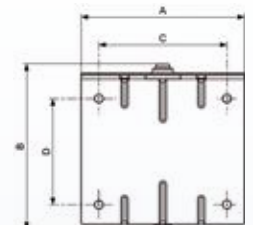

Spare parts

Typical exploded view - DPF hose reel

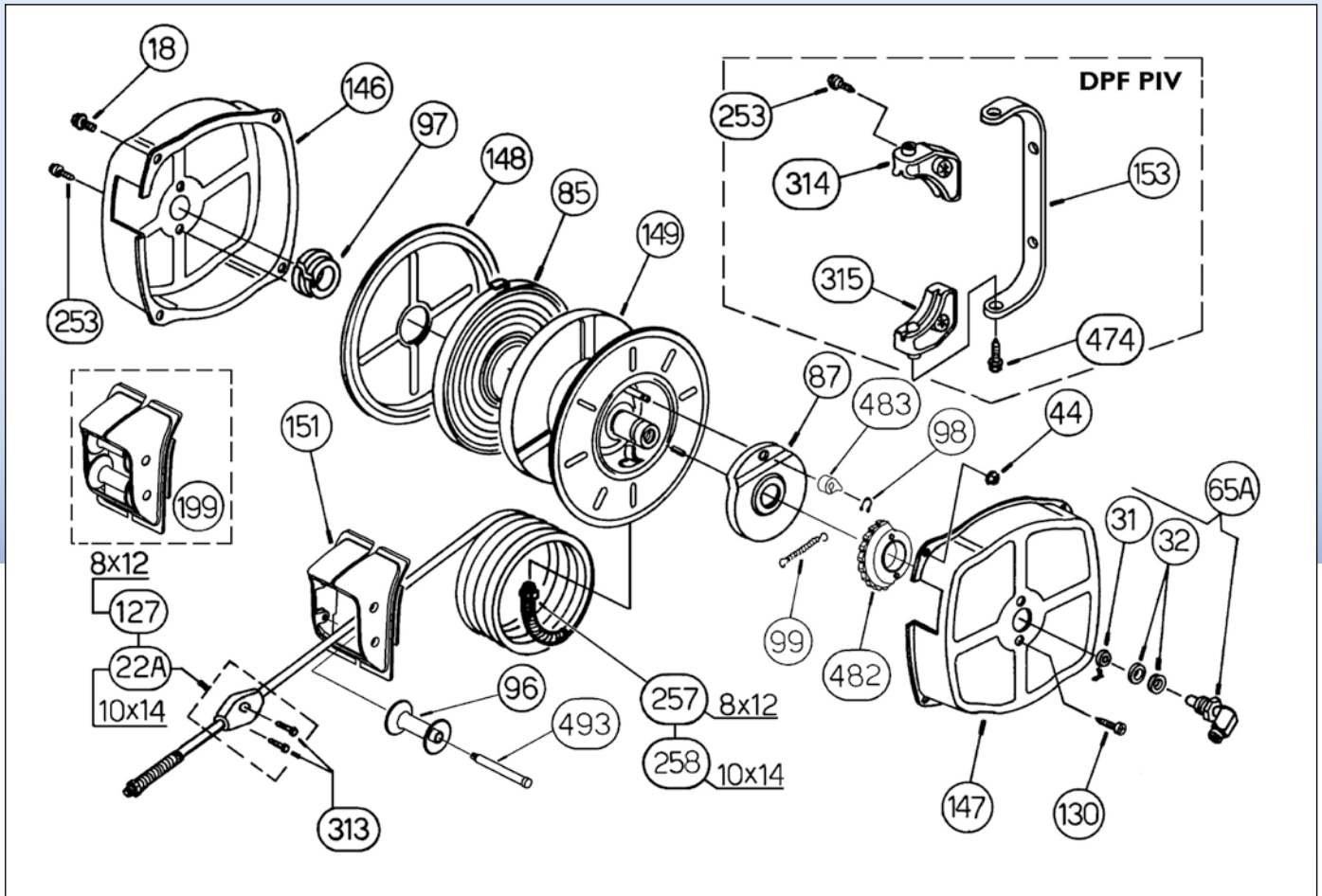

Spare parts for hose reels and spare hoses can be found on our website www.prevost.eu and in our general catalogue.

Each hose reel is presented as an exploded view with callouts corresponding to the list of part numbers.

All our ranges and new products are featured on www.prevost.eu.



All PREVOST automatic hose reels comply with the Machinery Directive 2006/42/EC.

The following rules are also applied:

- EN ISO 12100:2010-11-01 "Safety of machinery - General principles for design - Risk assessment and risk reduction"
- EN 13857:2008 "Safety of machinery - Safety distances to prevent hazard zones being reached by upper and lower limbs"



Head office: PREVOST SAS
C.S. 90208
74942 ANNECY-LE-VIEUX CEDEX - FRANCE
Tel. +33 (0)4 50 64 04 45 - Fax +33 (0)4 50 64 00 10
E-mail: sales@prevost.eu - www.prevost.eu

PREVOST UK
The Pavilions - Bridgefold Road
Rochdale OL11 5BX - United Kingdom
Tel. (+44) 0844 800 2788 - Fax (+44) 0844 800 2789
E-mail: sales@prevost-ltd.co.uk - www.prevost.eu



3660058240116



AUTHORISED DEALER

HR DOC13E

This document may not be held to be contractually binding.
To provide better service for customers, Prevost reserves the right
to alter product characteristics without notice.
Published by Prevost - 10-2013